



3S-IS

Irradiance Sensor

USER MANUAL

USER MANUAL TABLE OF CONTENTS

1. Introduction	2
2. Irradiance Sensors Installation	3
2.1. Unpacking and Control	4
2.2. Site Requirements and Considerations	5
2.3. Preparation of Materials to be Used in Installation	6
2.4. Installation	7
2.4.1. Installation With Mounting Structure	7
2.4.1.1. External Sensors	8
2.4.2. Installation Without Mounting Structure	9
2.4.2.1. Irradiance Sensor Installation	9
2.4.2.2. Module Temperature Sensor Installation	9
2.4.2.3. Ambient Temperature Sensor Installation	10
2.4.2.4. Wind Speed Sensor Installation	10
2.4.2.5. Wind Direction Sensor Installation	11
2.4.2.6. Relative Humidity Sensor Installation	12
2.5. Inspection and Maintenance	13
3. Test And Calibration	13
3.1. Recalibration	13
4. Connections	13
4.1. Irradiance Sensor (3S-IS)	14
4.2. 0-1.5V Irradiance Sensor (3S-IS-T-V)	15
4.3. 4-20 mA Irradiance Sensor (3S-IS-T-I)	15
4.4. Low-Cost Irradiance Sensor (3S-IS-LR)	16
5. Communication	16
5.1. 3S-IS Configuration Tool.....	16
5.2. Modbus RTU Specifications	17
5.2.1. Supported Bus Protocol.....	17
5.2.2. Supported Function Codes.....	17
5.2.2.1. Read Holding Registers (0x03)	17
5.2.2.2. Read Input Registers (0x04).....	19
5.2.2.3. Read & Change Parameters (0x46).....	20
5.2.2.4. Restart Communication Command (0x08).....	23
8. Additional Documents and Software	23
9. Contact Details	23

1. Introduction

Irradiance Sensors are a product of from the SEVEN meteorological sensors range of professional and intelligent measuring sensors with digital interface for environmental and industrial applications.



Figure 1 – Irradiance Sensor Set

The Irradiance Sensor is part of the SEVEN meteorological sensor range, which includes professional and intelligent measuring sensors with a digital or analog interface for environmental and industrial applications such as photovoltaic plants.

The Irradiance Sensor, called PV Pyranometer with photovoltaic reference cell, provide irradiance data in W/m^2 to the user to calculate the performance ratio of the PV plants.

Irradiance Sensors are available with various outputs according to customer requirements. The measured irradiance data is transmitted to data loggers and receiver units according to input requirements.

SEVEN products use reliable and high-quality components to provide accurate meteorological information in environmental and industrial applications. The Irradiance Sensor is specifically designed according to the requirements of PV plant monitoring systems, based on standards such as IEC 61724 and IEC 60904.



Note: SEVEN reserves the right to make changes in this entire document without prior notice.

Models

3S-IS

3S-IS Modbus Irradiance Sensor is designed for professional use in industrial, commercial, and utility-scale photovoltaic plants. The Irradiance Sensor operates as a hub for several sensors. All measured meteorological data are transmitted to dataloggers and receiver units via a 2-wire RS485 bus with Modbus RTU protocol.

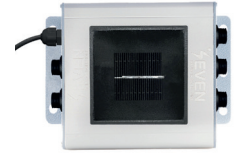

3S-IS-T-I

Irradiance sensors with analog 4-20 mA output measures irradiance and cell temperature data. The measured irradiance value is the temperature compensated. The 4-20 mA Irradiance Sensor is connected to suitable analog inputs of dataloggers or other receiver units.

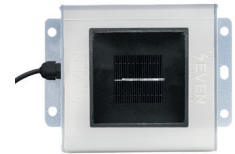

3S-IS-T-V

0-1,5 V Irradiance Sensor specially designed for SolarEdge datalogger. It is also compatible with other dataloggers and receiver units with the suitable inputs. 0-1,5 V Irradiance Sensor measures irradiance and cell temperature data. The measured irradiance value is the temperature compensated.

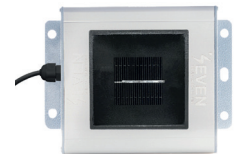

3S-IS-LR

The Low-Cost Irradiance Sensor is specially designed for residential and rooftop applications or small-scale PV applications. Advanced features and high accuracy for meteorological sensors are not required for these applications. The cost of the sensor should be proportional to the scale of the PV system. SEVEN achieved that by Low-Cost Irradiance Sensor. The measured irradiance value is transmitted to dataloggers and receiver units via a 2-wire RS485 bus with Modbus RTU protocol.



2. Irradiance Sensors Installation

It is suggested that the system be operated at ground level to make sure that all components are working properly prior to installation. A general diagram of the progress of the installation steps is given below.

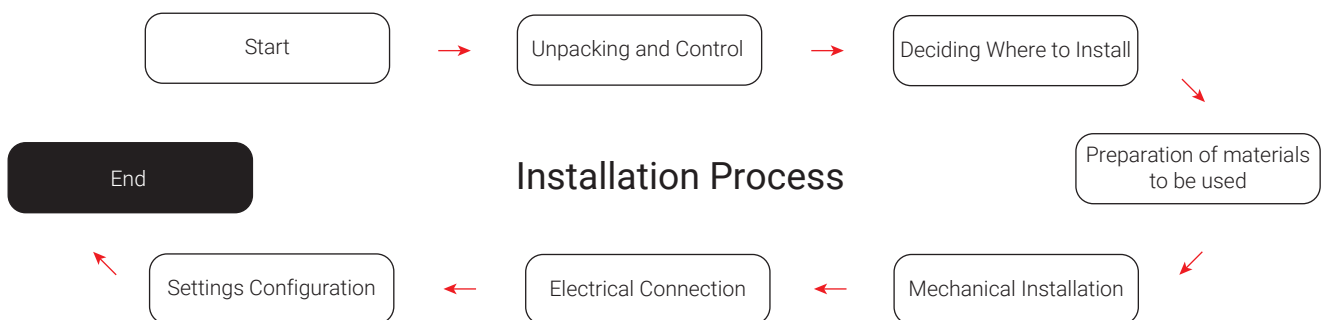

Figure 2 – Installation Process

2.1. Unpacking and Control

Upon receipt of the product, it must be carefully checked whether the package content is complete. Seven Sensor Solutions must be contacted if any of the components are missing, damaged or defective.

A Qty: 1	B Qty: 1	C Qty: 1	D Qty: 1	E Qty: 1	
Mounting Pole	20x40x1000 Profile	20x40x300 Profile	Irradiance Sensor Support Apparatus	Irradiance Sensor Connection Apparatus	
F Qty: 1	G Qty: 1	H Qty: 2	a Qty: 5	b Qty: 2	
Wind Speed Sensor Connection Sheet	Wind Direction Sensor Connection Sheet	Ambient Tmp. Sensor Connection Apparatus	M6x30 Hexagon Head Bolt	M6x50 Hexagon Head Bolt	
c Qty: 1	d Qty: 4	e Qty: 12	f Qty: 4	g Qty: 1	h Qty: 1
M6x55 Hexagon Head Bolt	M6x70 Hexagon Head Bolt	M6 Fibre Nut	20x40 Profile Plug	40x40 Profile Plug	Support Apparatus

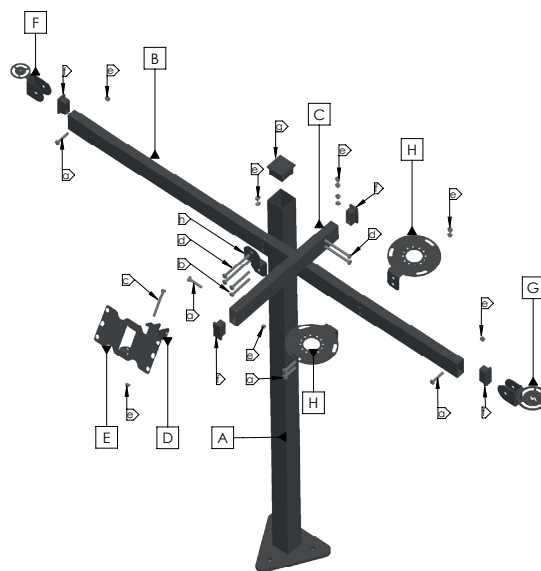



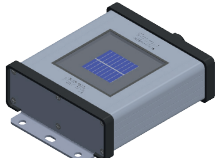



Figure 3 – Mounting Structure Packing List

			
A Qty: 1	B Qty: 1	C Qty: 1	
Wind Speed Sensor	Ambient Temperature Sensor	Humidity Sensor	
			
D Qty: 1	E Qty: 1	a Qty: 16	b Qty: 10
Wind Direction Sensor	Irradiance Sensor	M5x12 Hexagon Head Bolt	M5 Fibre Nut

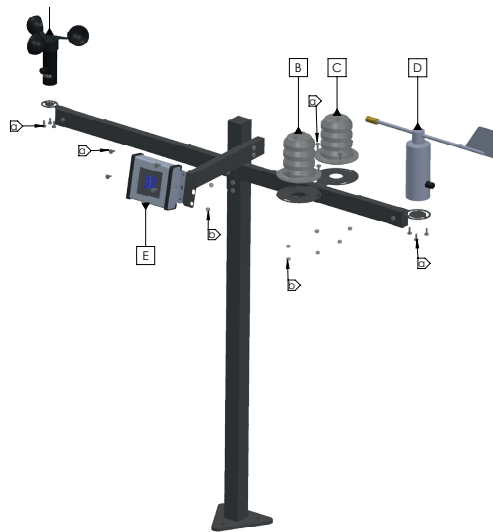

Figure 4 – External Sensors Packing List



Note: The installation and electrical connections of SEVEN sensors should be carried out by a qualified electrician.

2.2. Site Requirements and Considerations

Each site is different and has its own unique challenges. For this reason, the installation of the product may differ in each site. First of all, it should be decided where the product will be installed. Ambient temperature, plane of array irradiance, wind speed and direction can be affected by obstructions, shading source and local topography.

The Irradiance Sensor should be placed no closer than 10 times the height of any obstruction or shading source. It should also be placed away from any dark or reflective and heat-absorbing surfaces.

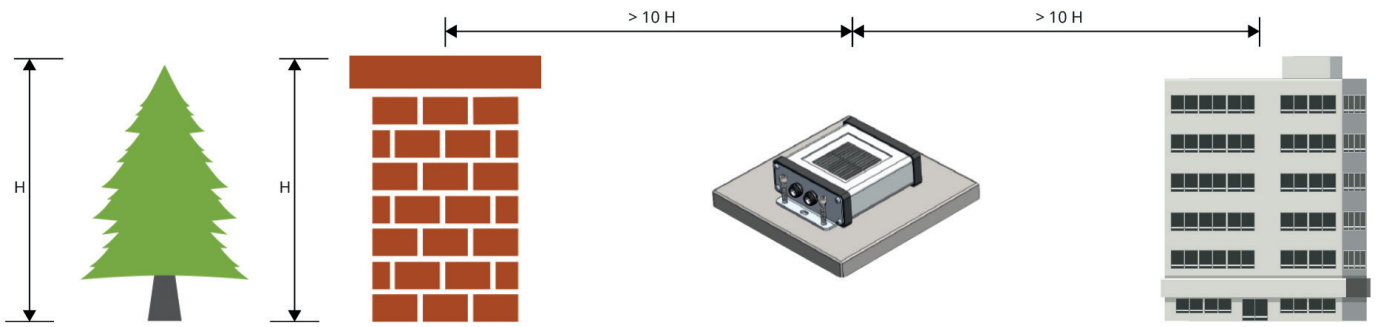

Figure 5 – Installation Site Selection

When the Irradiance Sensor set is to be mounted on a rooftop, it should preferably be mounted on the prevailing wind side of the building. It should also be avoided to place the station near any heat source such as chimneys or ventilation.

The Irradiance Sensor needs to be in the same direction and the same inclination as the solar panels. They should be positioned in the same or higher plane than the solar panels. The azimuth angle can be adjusted with a compass by rotating the mounting structure on its axis and the tilt angle can be adjusted with the protractor on the mounting structure.



Note: To facilitate the maintenance and cleaning of the Irradiance sensor, the Irradiance Sensor set must be installed in an easily accessible location, especially for rooftop projects.

2.3. Preparation of Materials to be Used in Installation

The materials needed during installation are provided by SEVEN. The user should only prepare the following hand tools and personal protective equipment.

Materials		
Gloves	Meter	Drill
6 mm Concrete Screw Drill Bit	Spirit Level	Digital Compass

Figure 6 – Materials to be Used in Installation

The Wind Direction Sensor and the Wind Speed Sensor should be installed at a height of 2 meters above the ground. It can be 1 meter for rooftop projects. There should not be any obstacles nearby that may impact the air flow, wind speed and wind direction. When placing the Wind Direction Sensor to the site, attention should be paid to the north direction mark and it should be aligned to the north with the help of a compass.

The Module Temperature Sensor must be installed at the exact midpoint of the solar panel. A sensor location should be chosen in the center of the cell closest to the exact midpoint of the module, avoiding the boundaries between cells. Module Temperature Sensor Installation Manual can be relieved for more detail.

Relative Humidity Sensor should be installed 15 meters away from the nearest plants or water bodies around it, as they have an impact on it.

2.4. Installation

3S-IS, 3S-IS-T-I, 3S-IS-T-V, and 3S-IS-LR Irradiance Sensors installation can be handled in 2 ways. Firstly, If the mounting structure is purchased by customer, 2.4.1 section must be follow. If the mounting structure is not purchased by customer, 2.4.2 section must be follow and the sensors must be fixed convenient location in the site.

2.4.1. Installation With Mounting Structure

The installation of the mounting structure in which the sensors are to be mounted is very simple and fast.

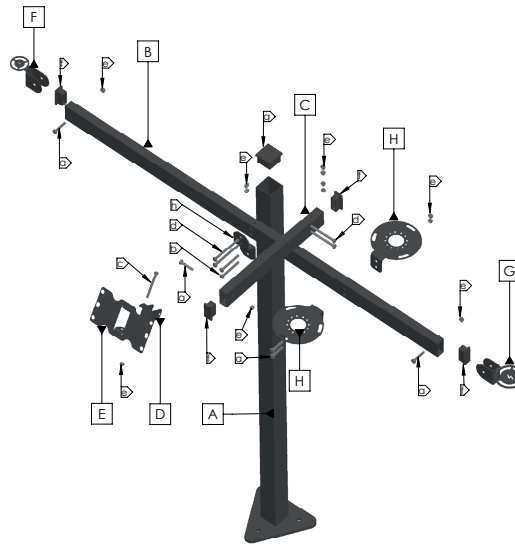

Figure 7 – Mounting Structure Installation

No	Part Name	Qty
A	Mounting Pole	1
B	Profile (20 x 40 x 1000 mm)	1
C	Profile (20 x 40 x 300 mm)	1
D	Irradiance Sensor Support Bracket	1
E	Irradiance Sensor Bracket	1
F	Wind Speed Sensor Bracket	1
G	Wind Direction Sensor Bracket	1
H	Ambient Temperature Sensor Bracket	2
a	M6 x 30 Hexagon Head Bolt	5
b	M6x50 Hexagon Head Bolt	2
c	M6x55 Hexagon Head Bolt	1
d	M6x55 Hexagon Head Bolt	4
e	M6 Fibre Nut	12
f	20x40 Profile Plug	4
g	40x40 Profile Plug	1
h	Support Bracket	1

2.4.1.1. External Sensors

The external sensors must be fixed to the mounting structure as shown below, after the installation of the mounting structure is completed.

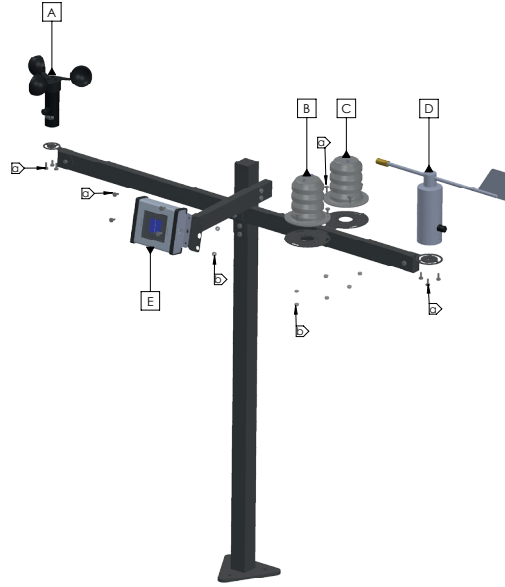
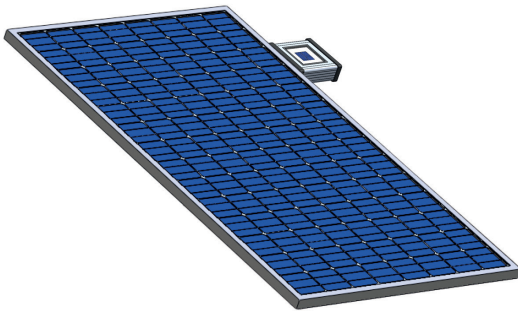

Figure 8 - External Sensors

No	Part Name	Material	Qty
A	Wind Speed Sensor	Anodized Aluminum Housing – ABS Cup	1
B	Ambient Temperature Sensor	ABS	1
C	Humidity & Pressure	ABS	1
D	Wind Direction Sensor	Polyamide / Aluminum Housing – Aluminum Vane	1
E	Irradiance Sensor	Aluminum	1
a	M5x12 Hexagon Head Bolt	Stainless Steel	16
b	M5 Fibre Nut	Stainless Steel	10

2.4.2. Installation Without Mounting Structure

2.4.2.1. Irradiance Sensor Installation



1st Step

The position of the irradiance sensor must be adjusted using the Spirit level. The angle of inclination should be the same as the solar panels. The Irradiance Sensor should be placed where the arrow (↓) is pointing down.

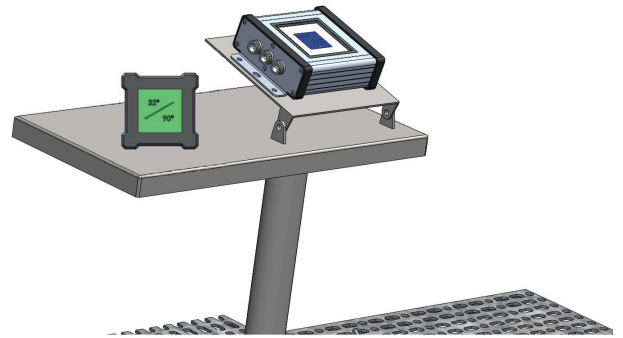

2st Step

4 M6 screws should be used to fix the Irradiance Sensor.

3st Step

The Irradiance Sensor should be fixed in the area by the drill.



Don't miss the arrow (↓) position.

There are ventilation holes on the box. If these holes are positioned on the top of the box, water may excess inside the box and damage the electronic card.

2.4.2.2. Module Temperature Sensor Installation

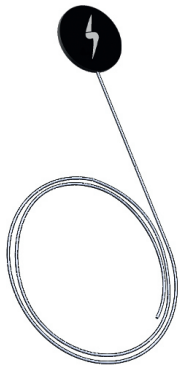

1st Step



1st Step

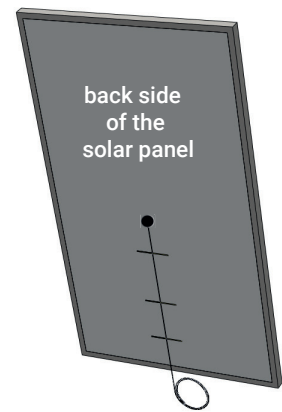

1st Step

The back side of the panel must be clean of oil and dust by using 70% isopropyl alcohol solution and a lint-free or particulate free cloth. Once the surface has been cleaned, we must then wait until it is completely dry.

The location of the sensor should not coincide with the intercellular spaces. When positioning the sensor, the most central cell of the PV system should be selected, and the module temperature sensor should be positioned in the middle of this cell.

To reduce the force on the Temperature Sensor, the sensor cable should be fixed to the back of the panel by using an adhesive crochet at 2 to 4 points.

2.4.2.3. Ambient Temperature Sensor Installation

Ambient Temperature Sensor should be mounted on a flat surface and in a shady position. Note: According to IEC 61724-1 standards, temperature sensor should be placed at least 1 meter away from the nearest PV Panel, it must be far from any thermal sources like transformer, asphalt, or roofing materials, etc. it should be placed where they will not be affected by thermal sources.

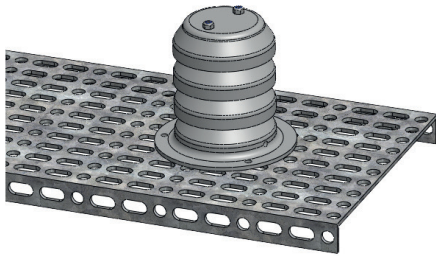

1st Step

The mounting area must be flat and parallel to the ground.

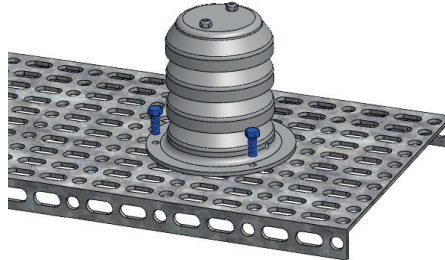

2st Step

3 M6 bolts and nuts should be used for assembly.

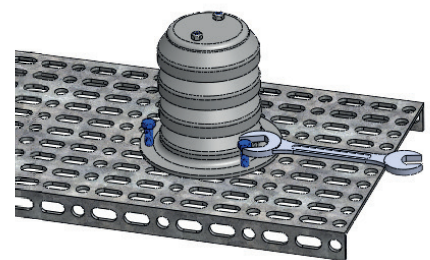

3st Step

The Ambient Temperature Sensor must be fixed in the area by a 10-11 size wrench.

2.4.2.4. Wind Speed Sensor Installation

The Wind Speed Sensor is mounted in 2 different ways, depending on the type of mounting.

Pipe Mounting



1st Step

Wind Speed Sensor must be placed on the pipe parallel to the ground.



2st Step

M6 Bolts should be inserted into the holes on the sides of the sensor.



3st Step

The bolts must be tightened by M4 allen. The pipe must be fixed on a flat surface.

Ground Mounting



1st Step

The mounting area must be flat and parallel to the ground.



2st Step

3 cylinder head inbuls M5*12 bolts and nuts should be used for assembly.



3st Step

Bolts should be tightened by a M4 Allen.

2.4.2.5. Wind Direction Sensor Installation

The Wind Direction Sensor is assembled in two different ways, depending on the mounting type.

Pipe Mounting

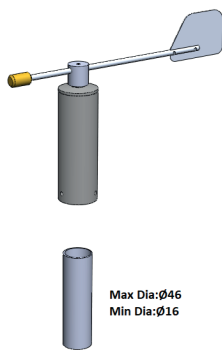

1st Step

Wind Direction Sensor must be placed on the pipe parallel to the ground.

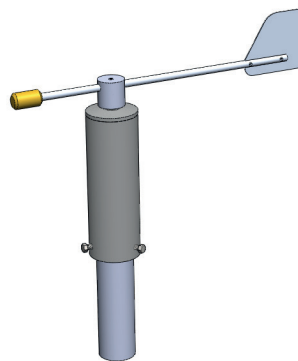

2st Step

M6 Bolts should be screwed into the holes on the sides of the sensor.

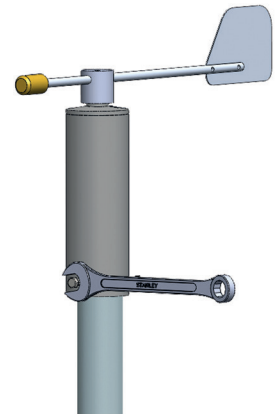

3st Step

Bolts should be tightened by a 10-11 wrench. The pipe must be fixed on a flat surface.

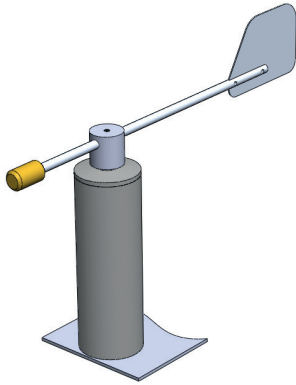

1st Step

The mounting area must be flat and parallel to the ground.

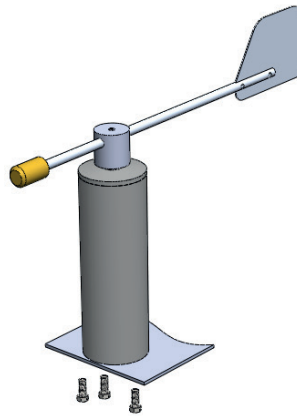

2st Step

3 M6 bolts and nuts should be used for assembly.

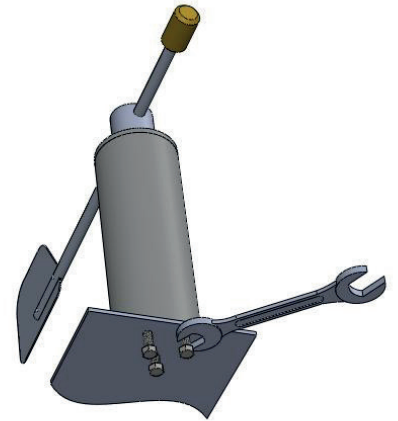

3st Step

Bolts should be tightened by a 10-11 wrench.

2.4.2.6. Relative Humidity Sensor Installation

The Wind Direction Sensor is assembled in two different ways, depending on the mounting type.

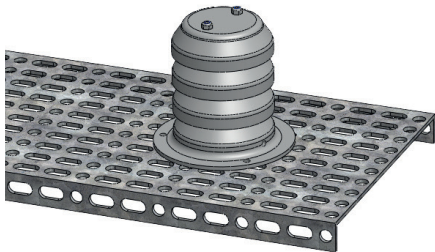

1st Step

The mounting area must be flat and parallel to the ground.

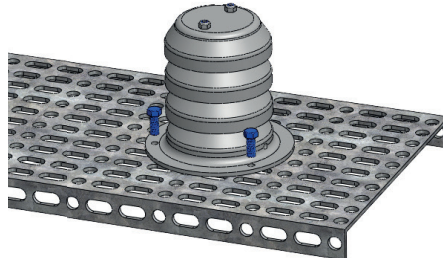

2st Step

3 M6 bolts and nuts should be used for assembly.

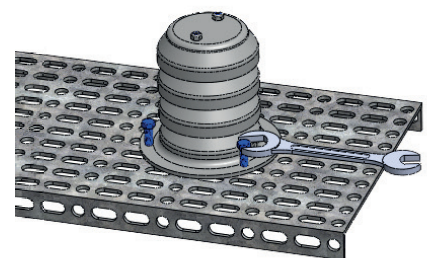

3st Step

Relative Humidity Sensor must be fixed in the appropriate position by 10-11 size wrench.

2.5. Inspection and Maintenance

Irradiance Sensor is not requiring any maintenance or changing of spare parts. However, the cleaning of the solar cell surface should be done periodically according to the standard which follow for site monitoring. The surface of the solar cell glass can be gently cleaned with a soft cloth and soapy water.

Fastener tightness and cable conditions, looking for damage, deterioration, or disconnection of sensors and electrical enclosures, soiling or displacement of optical sensors, evidence of moisture or vermin in enclosures, loose wiring connections, detachment of temperature sensors, embrittlement of attachments and other potential problems, should be checked periodically.



Note: We recommend to use thread-locking fluid for fasteners.

According to IEC 61724-1:2021, the monitoring system should be inspected at least annually and preferably at more frequent intervals.

3. Test and Calibration

SEVEN delivers all irradiance sensors with calibration certificates.

Each irradiance sensor is calibrated under Class AAA Sun Simulator according to IEC 60904-2 and IEC 60904-4 standards by using a reference cell calibrated by Institute for Solar Energy Research (ISFH) in Germany.

3.1. Recalibration

Recalibration of irradiance sensors according to IEC 61724-1 standard shall be conducted in a manner that minimizes downtime and sensor outages in order to prevent interruption of monitoring.

Effective methods may include:

- Exchanging installed sensors with new or recalibrated sensors
- Performing on-site recalibration of sensors where possible
- Providing redundant sensors and alternating laboratory recalibration schedules.

According to IEC 61724-1 standard, “for Class A systems, irradiance sensors shall be recalibrated once every 2 years, or more frequently per manufacturer recommendations. For Class B systems, recalibrate irradiance sensors according to manufacturer recommendations.”

The recommended recalibration period is at least once every 3 years from the installation of the irradiance sensors in the site.

4. Connections

The supply voltage for the Irradiance Sensor sets are 12 - 30 V DC. Operation with a supply voltage of 24 V is recommended.

The communication and power cable of Irradiance Sensors should be always laid separated from AC/DC cables.



Note: The installation and electrical connections of SEVEN sensors should be carried out by a qualified electrician.



Note: Compliance to IEC 61000-4-2 (ESD) and IEC 61000-4-5 (Surge) standards.

4.1. Irradiance Sensor (3S-IS)

External sensors are designed with the Plug & Run principle. The sensor connection box has waterproof and UV resistant connectors. Each external sensor has a different pin configuration, so wrong connection is not possible. The minimum bending radius at cables is 5 mm.

Connector Assignment for External Sensors

Wind Speed Sensor	2 pin Connector
Wind Direction Sensor	3 pin Connector
Module Temperature Sensor	4 pin Connector
Ambient Temperature Sensor	5 pin Connector
Humidity & Pressure & Temperature Sensor	7 pin Connector

The 3S-IS Irradiance Sensor has an electrically isolated, half-duplex, 2 wire RS485 interface for configuration, communication and the firmware update.

Wire Assignment for Power & Communication

RS485 Data Ground	Pink
RS485 A / Data (+)	Green
RS485 B / Data (-)	Yellow
Power (+)	Brown
Power (-)	White
Earth Ground	Black

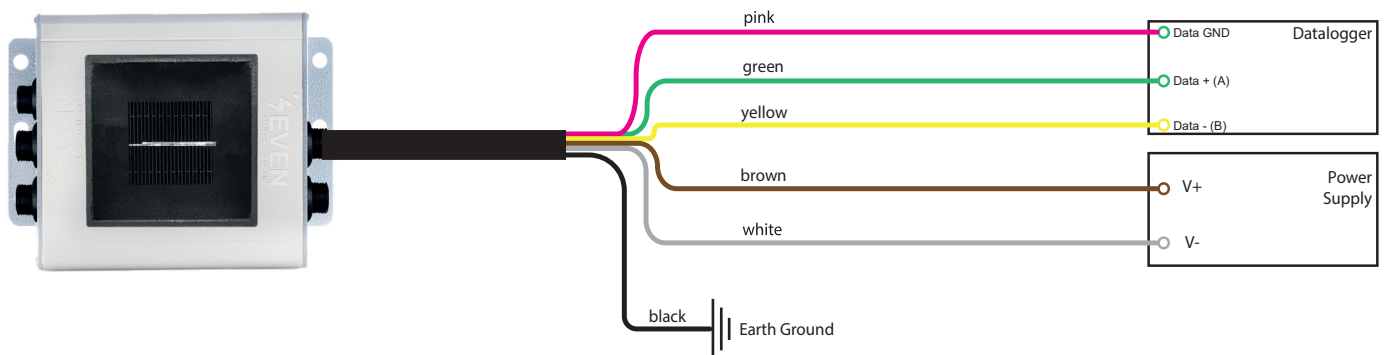

4.2. 0-1.5V Irradiance Sensor (3S-IS-T-V)

Wire Assignment for Power & Communication		
Data	Irradiance (+)	Blue
	Irradiance (-)	Red
	Temperature (+)	Green
	Temperature (-)	Yellow
Supply	Positive Supply Voltage	Brown
	Supply Voltage Ground	White

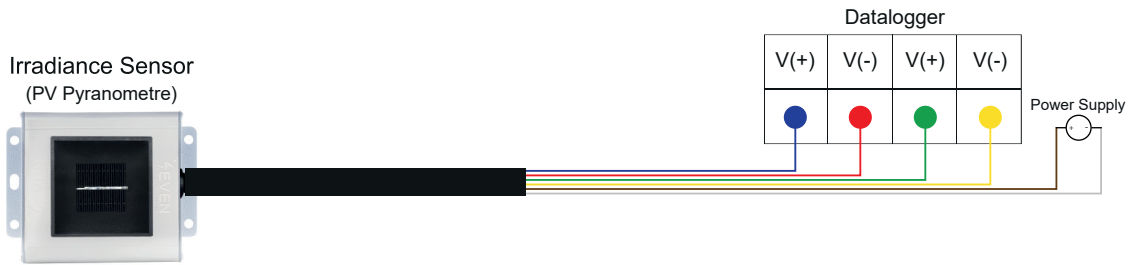

4.3. 4-20 mA Irradiance Sensor (3S-IS-T-I)

Wire Assignment for Power & Communication	
Irradiance Data	Green
Temperature Data	Yellow
Positive Supply Voltage	Brown
Supply Voltage Ground	White

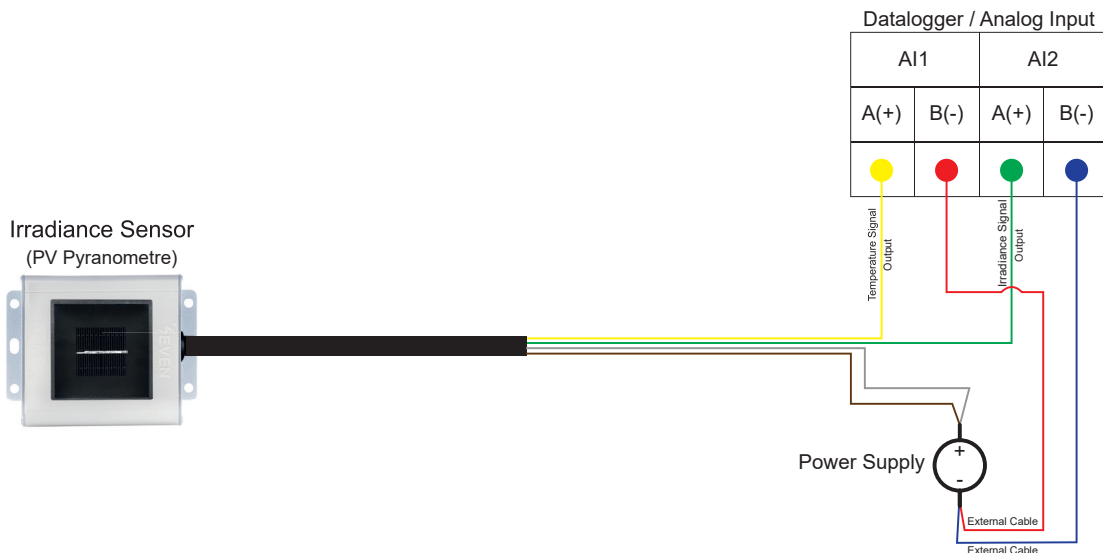

4.4. Low-Cost Irradiance Sensor (3S-IS-LR)

The 3S-IS-LR Irradiance Sensor has an electrically isolated, half-duplex, 2 wire RS485 interface for configuration, communication and the firmware update.

Wire Assignment for Power & Communication

Data (+)	Green
Data (-)	Yellow
Positive Supply Voltage	Brown
Supply Voltage Ground	White

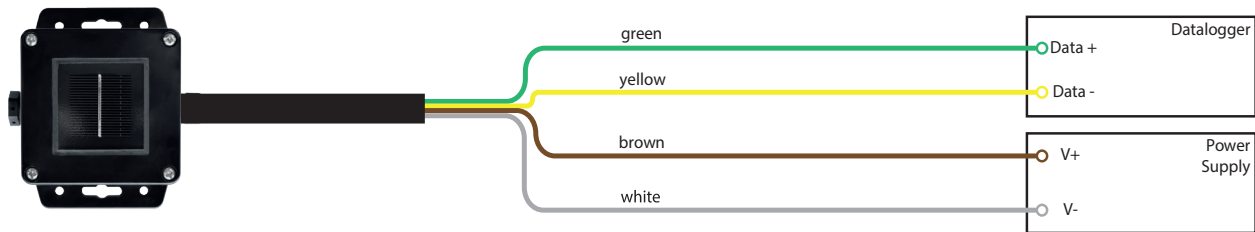

5. Communication

Once the Irradiance Sensor has been installed and connected correctly, the sensor begins autonomously to take measurements.

Attention must be paid to the following points:

- A measurement request should be made to the 3S-IS and 3S-IS-LR Irradiance Sensor with the 3S-IS Configuration Tool and it should be checked whether it correctly operation in the site.
- The Wind Direction Sensor must be aligned to the North in order to ensure correct wind measurement data.
- If several Modbus Device are operated on a network, a unique device ID must be assigned to each device.

Follow SEVEN instructions to configure the Irradiance Sensor on dataloggers.

5.1. 3S-IS Configuration Tool

3S-IS Configuration Tool is a software tool for testing communication and adjusting Modbus parameters on the 3S-IS and 3S-IS-LR Irradiance Sensors.

A Windows® PC with a serial bus interface set as a serial COM port, 3S-IS Configuration Tool software, and USB to RS485 Converter are required for configuration and testing purposes.

Follow the instructions in 3S-IS Configuration Tool User Manual:

https://www.sevensensor.com/files/d/en/3S-IS_Configuration_Tool_v3.0.pdf

5.2. Modbus RTU Specifications

5.2.1. Supported Bus Protocol

The Irradiance Sensor is equipped with an RS-485 communication port that supports Modbus RTU commands. The Irradiance Sensor can be configured to operate in different communication parameters. The table that follows describes each supported bus protocol.

Baud Rate	4800, 9600, 19200, 38400
Parity	None, Even, Odd
Stop Bit	1, 2 (only at None parity)
Factory Default	9600, 8N1, address: 1

5.2.2. Supported Function Codes

The Irradiance Sensor supports a specific subset of Modbus RTU commands. The table that follows lists each supported function code.

0x03	Read Holding Registers
0x04	Read Input Registers
0x46	Read & Change Parameters
0x08	Reset Communication Command



Note: All checksums of the Modbus protocol are omitted in this document. These checksums must always be calculated and sent during communication.

5.2.2.1. Read Holding Registers (0x03)

Master Request:

Address	1 Byte	1 to 247
Function Code	1 Byte	0x03
Start Register	2 Byte (Big Endian)	see the register table below
Number of Registers	2 Byte (Big Endian)	see the register table below

Slave Response:

Address	1 Byte	1 to 247
Function Code	1 Byte	0x03
Number of Bytes	1 Byte	0 to 255 (2xN) N = Number of Registers
Data	2 Byte x N (Big Endian)	see the register table below

Holding Register Map

The 3S-IS and 3S-IS-LR Irradiance Sensors holding register map is based on the “SunSpec Alliance” communication standards.

Start	End	Value	Type	Units	Scale Factor	Constant
40000	40001	SunSpec ID	uint32	N/A	N/A	"SunS"
40002	40002	SunSpec Device ID	uint16	N/A	N/A	0x0001
40003	40003	SunSpec Length	uint16	Registers	N/A	65
40004	40019	Manufacturer	String (32)	N/A	N/A	"SevenSensor"
40020	40035	Model	String (32)	N/A	N/A	"3S-IS"
40036	40043	Hardware Version	String (16)	N/A	N/A	"1.1"
40044	40051	Software Version	String (16)	N/A	N/A	"2.0"
40052	40067	Serial Number	String (32)	N/A	N/A	"23.12.345.65.0013"
40068	40068	Device ID	uint16	N/A	N/A	1
Sunspec Device Model Measurement Registers						
40069	40069	Block ID	int16	N/A	N/A	307
40070	40070	Length	int16	Registers	N/A	11
40071	40071	Air Temperature	int16	°C	0.1	Measured
40072	40072	Relative Humidity	int16	%	0	Measured
40073	40073	Barometric Pressure	int16	hPa	0	Measured
40074	40074	Wind Speed	int16	m/s	0.1	Measured
40075	40075	Wind Direction	int16	°	0	Measured
40076	40076	Rain Gauge (Hour)	int16	mm/hour	0	Measured
40077	40077	Snow	int16	inches	0	N/A
40078	40078	PPT Type	int16	inches	N/A	N/A
40079	40079	Electric Field	int16	V/m	0	N/A
40080	40080	Surface Wetness	int16	KOHms	0	N/A
40081	40081	Soil Moisture	int16	%	0	N/A
Irradiance Model Registers						
40082	40082	Block ID	int16	N/A	0	302
40083	40083	Length	int16	Registers	0	5
40084	40084	Plane of Array	uint16	W/m ²	0.1	Measured
40085	40085	Plane of Array 2	uint16	W/m ²	0.1	Measured
40086	40086	Diffuse Irradiance	uint16	W/m ²	0	N/A
40087	40087	Direct Irradiance	uint16	W/m ²	0	N/A
40088	40088	Total Effective Irradiance	uint16	W/m ²	0	N/A
Back of Module Temperature Registers						
40089	40089	Block ID	int16	N/A	N/A	303
40090	40090	Length	int16	Registers	N/A	9
40091	40091	Module Temp	int16	°C	0.1	Measured
40092	40092	Module Temp 1	int16	°C	0.1	N/A
40093	40093	Module Temp 2	int16	°C	0.1	N/A
40094	40094	Module Temp 3	int16	°C	0.1	N/A
40095	40095	Module Temp 4	int16	°C	0.1	N/A
40096	40096	Module Temp 5	int16	°C	0.1	N/A
40097	40097	Module Temp 6	int16	°C	0.1	N/A
40098	40098	Module Temp 7	int16	°C	0.1	N/A
40099	40099	Ambient Temp (SHT)	int16	°C	0.1	N/A
Device Model Measurement Registers						
40100	40100	Block ID	int16	N/A	N/A	308
40101	40101	Length	int16	Registers	N/A	5
40102	40102	Plane of Array	int16	W/m ²	0.1	N/A
40103	40103	Module Temp	int16	°C	0.1	Measured
40104	40104	Ambient Temp (SHT)	int16	°C	0.1	N/A
40105	40105	Wind Speed	int16	m/s	0.1	Measured
40106	40106	Air Temperature	int16	°C	0.1	Measured
End of Block Registers						
40107	40107	End of SunSpec Block	uint16	N/A	N/A	0xFFFF
40108	40108	Length	uint16	Registers	0	0
Device Address Read/Write Register						
40109	40109	Modbus ID – Write Register	uint16	N/A	N/A	1

5.2.2.2. Read Input Registers (0x04)

Master Request:

Address	1 Byte	1 to 247
Function Code	1 Byte	0x04
Start Register	2 Byte (Big Endian)	see the register table below
Number of Registers	2 Byte (Big Endian)	see the register table below

Slave Resonse:

Address	1 Byte	1 to 247
Function Code	1 Byte	0x04
Number of Bytes	1 Byte	0 to 255 (2xN) N = Number of Registers
Data	2 Byte x N (Big Endian)	see the register table below

Input Register Map

A standard input register map has been created for all SEVEN Modbus devices. The following Modbus data can be read individually or in blocks.

ID-Dec	ID-Hex	Value	Range	Resolution
30000	0x00	Irradiance	0...1600 W/m ²	0.1 W/m ²
30006	0x06	Temperature Compensated Irradiance	0...1600 W/m ²	0.1 W/m ²
30012	0x0C			
30014	0x0E	Albedo	0...1600 W/m ²	0.1 W/m ²
30015	0x0F	Internal Cell Temperature	-40...+85 °C	0.1°C
30021	0x15	Module Temperature	-40...+85 °C	1°C
30022	0x16		-40...+85 °C	0.1°C
30029	0x1D	Ambient Temperature	-40...+85 °C	0.1°C
30032	0x20	Ambient Temperature (SHT)	-40...+85 °C	0.1°C
30033	0x21	Relative Humidity (SHT)	0...100%	0.1%
30052	0x34	Wind Direction	0...359°	1°
30053	0x35	Wind Speed (m/s)	0...40 m/s	0.1 m/s

Additionally, the following internal data marked in bold can be read individually or in blocks.

ID-Dec	ID-Hex	Value	Range
30301	0x12D	Hardware Version	Manufacturer Parameters Read Only
30302	0x12E	Software Version	
30304	0x130	Calibration Value	
30310	0x136	Temperature Coefficient Value	
30323	0x143	ADC Offset Value	
30329	0x149	T90 value	
30330	0x14A	Wind Speed Sensor Offset Value	
30331	0x14B	Wind Speed Sensor Slope High Value	
30332	0x14C	Wind Speed Sensor Slope Low Value	
30333	0x14D	Wind Speed Sensor Interval Value	
30342	0x156	Production Year	
30343	0x157	Production Code	
30344	0x158	Cell Serial Number	
30345	0x159	Board Serial Number	
30346	0x15A	Box Serial Number	
30347	0x15B	Sensor Serial Number	
30345	0x159	Production Day	
30346	0x15A	Production Month	
30347	0x15B	Production Year	
30351	0x15F	Calibration Day	
30352	0x160	Calibration Month	
30353	0x161	Calibration Year	

5.2.2.3. Read & Change Parameters (0x46)

Sub Function (0x04): Write Device Address

Master Request:

Address	1 Byte	1 to 247
Function Code	1 Byte	0x46
Sub Function Code	1 Byte	0x04
New Address	1 Byte	1 to 247

Slave Response:

Address	1 Byte	1 to 247
Function Code	1 Byte	0x46
Sub Function Code	1 Byte	0x04
New Address	1 Byte	1 to 247

Sub Function (0x06): Write Communication Parameters

Master Request:

Address	1 Byte	1 to 247
Function Code	1 Byte	0x46
Sub Function Code	1 Byte	0x06
New Baud Rate	1 Byte	0 to 3, see table below
New Parity / Stop Bit	1 Byte	0 to 3, see table below

Slave Response:

Address	1 Byte	1 to 247
Function Code	1 Byte	0x46
Sub Function Code	1 Byte	0x06
New Baud Rate	1 Byte	0 to 3, see table below
New Parity / Stop Bit	1 Byte	0 to 3, see table below



Note: When the “Write Communication Parameters” command is used, the “Write Device Address” command must also be used before the restart communication command.

Communication Parameter Settings

Parameter changes will take effect after restart of the sensor by power on reset or restart communication command.

Baud Rate	Value	Parity / Stop Bit	Value
4800	0	None/1	0
9600	1	None/2	1
19200	2	Odd	2
38400	3	Even	3

Sub Function (0x07): Read Hardware & Software Versions

Master Request:

Address	1 Byte	1 to 247
Function Code	1 Byte	0x46
Sub Function Code	1 Byte	0x07

Slave Response:

Address	1 Byte	1 to 247
Function Code	1 Byte	0x46
Sub Function Code	1 Byte	0x07
Hardware Version	2 Byte (Little Endian)	0 to 65535
Software Version	2 Byte (Little Endian)	0 to 65535

Sub Function (0x08): Read Serial Number - Production Date - Calibration Date

Master Request:

Address	1 Byte	1 to 247
Function Code	1 Byte	0x46
Sub Function Code	1 Byte	0x08

Slave Response:

Address	1 Byte	1 to 247
Function Code	1 Byte	0x46
Sub Function Code	1 Byte	0x08
Production Year	1 Byte	0 to 99
Production Code	1 Byte	0 to 99
Cell Serial Number	2 Byte (Little Endian)	0 to 999
Board Serial Number	1 Byte	0 to 99
Box Serial Number	1 Byte	0 to 99
Sensor Serial Number	2 Byte (Big Endian)	0 to 9999
Production Day	1 Byte	1 to 31
Production Month	1 Byte	1 to 12
Production Year	1 Byte	0 to 99
Calibration Day 1	1 Byte	1 to 31
Calibration Month 1	1 Byte	1 to 12
Calibration Year 1	1 Byte	0 to 99
Calibration Day 2	1 Byte	1 to 31
Calibration Month 2	1 Byte	1 to 12
Calibration Year 2	1 Byte	0 to 99
Sub Function Code	1 Byte	0x08
Production Year	1 Byte	0 to 99
Production Code	1 Byte	0 to 99
Cell Serial Number	2 Byte (Little Endian)	0 to 999
Calibration Day 3	1 Byte	1 to 31
Calibration Month 3	1 Byte	1 to 12
Calibration Year 3	1 Byte	0 to 99
Calibration Day 4	1 Byte	1 to 31
Calibration Month 4	1 Byte	1 to 12
Calibration Year 4	1 Byte	0 to 99

5.2.2.4. Restart Communication Command (0x08)

Master Request:

Address	1 Byte	1 to 247
Function Code	1 Byte	0x08
Restart Code	4 Byte	0x00000000

Slave Response:

Address	1 Byte	1 to 247
Function Code	1 Byte	0x08
Restart Code	4 Byte	0x00000000

6. Additional Documents and Software

The following documents and software can be downloaded from www.sevensensor.com or requested from SEVEN Sensor Solutions.

User Manual	This document
Datasheet	Irradiance Sensor brochure
3S-IS Configuration Tool	Windows® software for testing, firmware updates and configuration of the device
Firmware	Current device firmware

7. Contact Details

Please feel free to contact us if you face any difficulties during installation or configuration.

Address	Pınarcay OSB Mahallesi Organize Sanayi Tesisleri Teknokent Idare Binası o: 7, D:1, 19100 Merkez / Corum / Turkey
Phone	+90 530 889 8019 / +90 544 919 8328
Email	teknik@sevensensor.com
Website	www.sevensensor.com